



ProFlex™ 800 CORS

powered by
ashtech



Getting Started Guide

CORS
Reference Station

Copyright Notice

Copyright 2012 Ashtech. All rights reserved.

Trademarks

All product and brand names mentioned in this publication are trademarks of their respective holders.

Ashtech Products - Limited Warranty (North, Central and South America)

Ashtech warrants their GPS receivers and hardware accessories to be free of defects in material and workmanship and will conform to our published specifications for the product for a period of one year from the date of original purchase. THIS WARRANTY APPLIES ONLY TO THE ORIGINAL PURCHASER OF THIS PRODUCT.

In the event of a defect, Ashtech will, at its option, repair or replace the hardware product with no charge to the purchaser for parts or labor. The repaired or replaced product will be warranted for 90 days from the date of return shipment, or for the balance of the original warranty, whichever is longer. Ashtech warrants that software products or software included in hardware products will be free from defects in the media for a period of 30 days from the date of shipment and will substantially conform to the then-current user documentation provided with the software (including updates thereto). Ashtech's sole obligation shall be the correction or replacement of the media or the software so that it will substantially conform to the then-current user documentation. Ashtech does not warrant the software will meet purchaser's requirements or that its operation will be uninterrupted, error-free or virus-free. Purchaser assumes the entire risk of using the software.

PURCHASER'S EXCLUSIVE REMEDY UNDER THIS WRITTEN WARRANTY OR ANY IMPLIED WARRANTY SHALL BE LIMITED TO THE REPAIR OR REPLACEMENT, AT ASHTECH'S OPTION, OF ANY DEFECTIVE PART OF THE RECEIVER OR ACCESSORIES WHICH ARE COVERED BY THIS WARRANTY. REPAIRS UNDER THIS WARRANTY SHALL ONLY BE MADE AT AN AUTHORIZED ASHTECH SERVICE CENTER. ANY REPAIRS BY A SERVICE CENTER NOT AUTHORIZED BY ASHTECH WILL VOID THIS WARRANTY.

To obtain warranty service the purchaser must obtain a Return Materials Authorization (RMA) number prior to shipping by calling 1-800-229-2400 (North America) or 1-408-572-1134 (International) and leaving a voice mail at option 3, or by submitting a repair request on-line at: <http://ashtech.com> (fill out the RMA request from under the Support tab). The purchaser must return the product postpaid with a copy of the original sales receipt to the address provided by Ashtech with the RMA number. Purchaser's return address and the RMA number must be clearly printed on the outside of the package.

Ashtech reserves the right to refuse to provide service free-of-charge if the sales receipt is not provided or if the information contained in it is incomplete or illegible or if the serial number is altered or removed. Ashtech will not be responsible for any losses or damage to the product incurred while the product is in transit or is being shipped for repair. Insurance is recommended. Ashtech suggests using a trackable shipping method such as UPS or FedEx when returning a product for service.

EXCEPT AS SET FORTH IN THIS LIMITED WARRANTY, ALL OTHER EXPRESSED OR IMPLIED WARRANTIES, INCLUDING THOSE OF FITNESS

FOR ANY PARTICULAR PURPOSE, MERCHANTABILITY OR NON-INFRINGEMENT, ARE HEREBY DISCLAIMED AND IF APPLICABLE, IMPLIED WARRANTIES UNDER ARTICLE 35 OF THE UNITED NATIONS CONVENTION ON CONTRACTS FOR THE INTERNATIONAL SALE OF GOODS. Some national, state, or local laws do not allow limitations on implied warranty or how long an implied warranty lasts, so the above limitation may not apply to you.

The following are excluded from the warranty coverage: (1) periodic maintenance and repair or replacement of parts due to normal wear and tear; (2) batteries and finishes; (3) installations or defects resulting from installation; (4) any damage caused by (i) shipping, misuse, abuse, negligence, tampering, or improper use; (ii) disasters such as fire, flood, wind, and lightning; (iii) unauthorized attachments or modification; (5) service performed or attempted by anyone other than an authorized Ashtech Service Center; (6) any product, components or parts not manufactured by Ashtech; (7) that the receiver will be free from any claim for infringement of any patent, trademark, copyright or other proprietary right, including trade secrets; and (8) any damage due to accident, resulting from inaccurate satellite transmissions. Inaccurate transmissions can occur due to changes in the position, health or geometry of a satellite or modifications to the receiver that may be required due to any change in the GPS. (Note: Ashtech GPS receivers use GPS or GPS+GLONASS to obtain position, velocity and time information. GPS is operated by the U.S. Government and GLONASS is the Global Navigation Satellite System of the Russian Federation, which are solely responsible for the accuracy and maintenance of their systems. Certain conditions can cause inaccuracies which could require modifications to the receiver. Examples of such conditions include but are not limited to changes in the GPS or GLONASS transmission.) Opening, dismantling or repairing of this product by anyone other than an authorized Ashtech Service Center will void this warranty.

ASHTECH SHALL NOT BE LIABLE TO PURCHASER OR ANY OTHER PERSON FOR ANY INCIDENTAL OR CONSEQUENTIAL DAMAGES WHATSOEVER, INCLUDING BUT NOT LIMITED TO LOST PROFITS, DAMAGES RESULTING FROM DELAY OR LOSS OF USE, LOSS OF OR DAMAGES ARISING OUT OF BREACH OF THIS WARRANTY OR ANY IMPLIED WARRANTY EVEN THOUGH CAUSED BY NEGLIGENCE OR OTHER FAULT OF ASHTECH OR NEGLIGENT USAGE OF THE PRODUCT. IN NO EVENT WILL ASHTECH BE RESPONSIBLE FOR SUCH DAMAGES, EVEN IF ASHTECH HAS BEEN ADVISED OF THE POSSIBILITY OF SUCH DAMAGES.

This written warranty is the complete, final and exclusive agreement between Ashtech and the purchaser with respect to the quality of performance of the goods and any and all warranties and representations. This warranty sets forth all of Ashtech's responsibilities regarding this product. This limited warranty is governed by the laws of the State of California, without reference to its conflict of law provisions or the U.N. Convention on Contracts for the International Sale of Goods, and shall benefit Ashtech, its successors and assigns.

This warranty gives the purchaser specific rights. The purchaser may have other rights which vary from locality to locality (including Directive 1999/44/EC in the EC Member States) and certain limitations contained in this warranty, including the exclusion or

limitation of incidental or consequential damages may not apply.

For further information concerning this limited warranty, please call or write:

Ashtech SAS - ZAC La Fleuriaye - BP 433 - 44474 Carquefou Cedex - France Phone: +33 (0)2 28 09 38 00, Fax: +33 (0)2 28 09 39 39.

Ashtech Products Limited Warranty (Europe, Middle East, Africa)

All Ashtech global positioning system (GPS) receivers are navigation aids, and are not intended to replace other methods of navigation. Purchaser is advised to perform careful position charting and use good judgment. READ THE USER GUIDE CAREFULLY BEFORE USING THE PRODUCT.

1. ASHTECH WARRANTY

Ashtech warrants their GPS receivers and hardware accessories to be free of defects in material and workmanship and will conform to our published specifications for the product for a period of one year from the date of original purchase or such longer period as required by law. THIS WARRANTY APPLIES ONLY TO THE ORIGINAL PURCHASER OF THIS PRODUCT.

In the event of a defect, Ashtech will, at its option, repair or replace the hardware product with no charge to the purchaser for parts or labor. The repaired or replaced product will be warranted for 90 days from the date of return shipment, or for the balance of the original warranty, whichever is longer. Ashtech warrants that software products or software included in hardware products will be free from defects in the media for a period of 30 days from the date of shipment and will substantially conform to the then-current user documentation provided with the software (including updates thereto). Ashtech's sole obligation shall be the correction or replacement of the media or the software so that it will substantially conform to the then-current user documentation. Ashtech does not warrant the software will meet purchaser's requirements or that its operation will be uninterrupted, error-free or virus-free. Purchaser assumes the entire risk of using the software.

2. PURCHASER'S REMEDY

PURCHASER'S EXCLUSIVE REMEDY UNDER THIS WRITTEN WARRANTY OR ANY IMPLIED WARRANTY SHALL BE LIMITED TO THE REPAIR OR REPLACEMENT, AT ASHTECH'S OPTION, OF ANY DEFECTIVE PART OF THE RECEIVER OR ACCESSORIES WHICH ARE COVERED BY THIS WARRANTY. REPAIRS UNDER THIS WARRANTY SHALL ONLY BE MADE AT AN AUTHORIZED ASHTECH SERVICE CENTER. ANY REPAIRS BY A SERVICE CENTER NOT AUTHORIZED BY ASHTECH WILL VOID THIS WARRANTY.

3. PURCHASER'S DUTIES

To obtain service, contact and return the product with a copy of the original sales receipt to the dealer from whom you purchased the product.

Ashtech reserves the right to refuse to provide service free-of-charge if the sales receipt is not provided or if the information contained in it is incomplete or illegible or if the serial number is altered or removed. Ashtech will not be responsible for any losses or damage to the product incurred while the product is in transit or is being shipped for repair. Insurance is recommended. Ashtech suggests using a trackable

shipping method such as UPS or FedEx when returning a product for service.

4. LIMITATION OF IMPLIED WARRANTIES

EXCEPT AS SET FORTH IN ITEM 1 ABOVE, ALL OTHER EXPRESSED OR IMPLIED WARRANTIES, INCLUDING THOSE OF FITNESS FOR ANY PARTICULAR PURPOSE OR MERCHANTABILITY, ARE HEREBY DISCLAIMED AND IF APPLICABLE, IMPLIED WARRANTIES UNDER ARTICLE 35 OF THE UNITED NATIONS CONVENTION ON CONTRACTS FOR THE INTERNATIONAL SALE OF GOODS.

Some national, state, or local laws do not allow limitations on implied warranty or how long an implied warranty lasts, so the above limitation may not apply to you.

5. EXCLUSIONS

The following are excluded from the warranty coverage:

- (1) periodic maintenance and repair or replacement of parts due to normal wear and tear;
- (2) batteries;
- (3) finishes;
- (4) installations or defects resulting from installation;
- (5) any damage caused by (i) shipping, misuse, abuse, negligence, tampering, or improper use; (ii) disasters such as fire, flood, wind, and lightning; (iii) unauthorized attachments or modification;
- (6) service performed or attempted by anyone other than an authorized Ashtech Service Center;
- (7) any product, components or parts not manufactured by Ashtech,
- (8) that the receiver will be free from any claim for infringement of any patent, trademark, copyright or other proprietary right, including trade secrets
- (9) any damage due to accident, resulting from inaccurate satellite transmissions. Inaccurate transmissions can occur due to changes in the position, health or geometry of a satellite or modifications to the receiver that may be required due to any change in the GPS. (Note: Ashtech GPS receivers use GPS or GPS+GLONASS to obtain position, velocity and time information. GPS is operated by the U.S. Government and GLONASS is the Global Navigation Satellite System of the Russian Federation, which are solely responsible for the accuracy and maintenance of their systems. Certain conditions can cause inaccuracies which could require modifications to the receiver. Examples of such conditions include but are not limited to changes in the GPS or GLONASS transmission.)

Opening, dismantling or repairing of this product by anyone other than an authorized Ashtech Service Center will void this warranty.

6. EXCLUSION OF INCIDENTAL OR CONSEQUENTIAL DAMAGES

ASHTECH SHALL NOT BE LIABLE TO PURCHASER OR ANY OTHER PERSON FOR ANY INDIRECT, INCIDENTAL OR CONSEQUENTIAL DAMAGES WHATSOEVER, INCLUDING BUT NOT LIMITED TO LOST PROFITS, DAMAGES RESULTING FROM DELAY OR LOSS OF USE, LOSS OF OR DAMAGES ARISING OUT OF BREACH OF THIS WARRANTY OR ANY IMPLIED WARRANTY EVEN THOUGH CAUSED BY NEGLIGENCE OR OTHER FAULT OF ASHTECH OR NEGLIGENT USAGE OF THE PRODUCT. IN NO

EVENT WILL ASHTECH BE RESPONSIBLE FOR SUCH DAMAGES, EVEN IF ASHTECH HAS BEEN ADVISED OF THE POSSIBILITY OF SUCH DAMAGES.

Some national, state, or local laws do not allow the exclusion or limitation of incidental or consequential damages, so the above limitation or exclusion may not apply to you.

7. COMPLETE AGREEMENT

This written warranty is the complete, final and exclusive agreement between Ashtech and the purchaser with respect to the quality of performance of the goods and any and all warranties and representations. THIS WARRANTY SETS FORTH ALL OF ASHTECH'S RESPONSIBILITIES REGARDING THIS PRODUCT.

THIS WARRANTY GIVES YOU SPECIFIC RIGHTS. YOU MAY HAVE OTHER RIGHTS WHICH VARY FROM LOCALITY TO LOCALITY (including Directive 1999/44/EC in the EC Member States) AND CERTAIN LIMITATIONS CONTAINED IN THIS WARRANTY MAY NOT APPLY TO YOU.

8. CHOICE OF LAW.

This limited warranty is governed by the laws of France, without reference to its conflict of law provisions or the U.N. Convention on Contracts for the International Sale of Goods, and shall benefit Ashtech, its successors and assigns.

THIS WARRANTY DOES NOT AFFECT THE CUSTOMER'S STATUTORY RIGHTS UNDER APPLICABLE LAWS IN FORCE IN THEIR LOCALITY, NOR THE CUSTOMER'S RIGHTS AGAINST THE DEALER ARISING FROM THEIR SALES/PURCHASE CONTRACT (such as the guarantees in France for latent defects in accordance with Article 1641 et seq of the French Civil Code).

For further information concerning this limited warranty, please call or write:

Ashtech SAS - ZAC La Fleuriaye - BP 433 - 44474 Carquefou Cedex - France.

Phone: +33 (0)2 28 09 38 00, Fax: +33 (0)2 28 09 39 39

Table of Contents

What is ProFlex 800 CORS?	1
Hardware Description	3
System Components Overview	3
Basic Supply	3
Optional Accessories	4
Equipment Description & Basic Functions.....	5
Front View	5
Rear View	7
Buzzer	9
Battery Model & Battery Compartment	9
Special Button Combinations	10
Charging Batteries Before Use	10
Removing the Battery from the ProFlex 800.....	11
Charging the Battery.....	11
Inserting the Battery in the ProFlex 800	12
Display Screens.....	12
Power-On Screen	13
General Status Screen	13
Memory Screens	15
Receiver Identification Screen	16
Position Computation Screen	16
ATL Recording Screen	17
Screen Backlight.....	18
Data Transfer Screen	18
How to Safely Power the ProFlex 800 CORS.....	18
Introduction to ProFlex 800 CORS Configuration	20
Introductory Notes	20
Creating Sessions	21
Raw Data Types and Files Collected During Sessions.....	23
Storing G-Files Collected During Sessions	23
Converting/Deleting G-Files Collected During Sessions	24
Moving Files Originating from Sessions.....	24
Pushing Files Originating from Sessions to an External FTP Server - Backup FTP Server.....	25
Recording Raw Data Outside of Any Sessions	27
Embedded NTRIP Caster.....	28
Introduction.....	28
NTRIP Caster Control & Monitoring	30
Map	32
Protecting Mount Points	32
E-mail Notifications.....	32
Embedded FTP Server.....	33
External Sensors.....	34
First Steps With the Web Server	36
Home Tab.....	36
Status Bar and Units Used	37
Distance Units.....	39

Angle Units	39
Time Units	40
Setting a CORS Reference Station.....	41
How to Start.....	41
General Parameters.....	41
Defining the Raw Data Generated by the CORS Station	43
Programming Sessions	44
Starting Sessions & Managing Raw Data Files.....	45
Programming Email Notifications	47
Activating the Embedded FTP Server & Creating New Users.....	48
Setting the External Sensors	49
Adding Delivery of Real-Time RTK Corrections.....	50
NTRIP Server Via Ethernet.....	51
Setting the Embedded NTRIP Caster	51
Monitoring ProFlex 800 CORS	54

What is ProFlex 800 CORS?



ProFlex 800 CORS is a rugged and high-performance CORS reference station. Designed as an extension of the ProFlex 800 receiver, ProFlex 800 CORS integrates the best of today's technologies, including the exclusive Z-Blade™ algorithms and multi-constellation (GPS+GLONASS+ GALILEO+SBAS) capabilities.

The main features of ProFlex 800 CORS are the following:

- Embedded Z-Blade technology guarantees outstanding quality, availability and reliability of raw data acquisition, providing the best possible measurements from four GNSS constellations: GPS (including L5), GLONASS, SBAS and GALILEO.
- Extended internal memory (8 Gbytes) for data storage.
- Embedded and password-protected *Web Server* giving the owner full remote control of the reference station via an Internet connection. The Web Server returns web pages on the owner's computer that give the owner the capability to monitor the operation of the reference station, or change partially or completely its settings.
- Generation of raw data files entirely manageable through the Web Server. Data recording is organized as sessions, with preset duration, ensuring round-the-clock data recording, day after day and year after year.
- Raw data files can be converted to Rinex 2.11, Rinex 3.01, Hatanaka or TarZ before being made available to users. RINEX conversion is performed on the fly (RINEX file is available immediately after a session is finished to meet rapid and ultra-rapid IGS services requirements). Up to two RINEX files with two different periods can be generated simultaneously.
- Embedded *Ring File memory* function offering unlimited use of the storage medium. Enabling this function will allow the oldest files in memory to be automatically deleted if necessary to provide storage space for current files being recorded.
- Raw data files can be pushed automatically to an external FTP server. A backup FTP server can also be planned, either as a fallback FTP server in case the primary FTP fails, or as a second repository for data files.
- *Embedded NTRIP caster* (firmware option) offering the possibility of implementing a complete network service according to the NTRIP protocol. Using this protocol

makes it possible to access various sources of data from different base stations through a single Internet connection, as well as efficiently protect these sources of corrections from unauthorized users.

The embedded NTRIP caster allows you to organize a network of up to 10 different mount points (each of them receiving corrections from an NTRIP server) and up to 100 users given the ability to receive corrections through these mount points.

- Smooth integration of meteorological and tilt data. Meteo and tiltmeter sensors fully controlled by the receiver.
- *Embedded FTP server* allowing the administrator to perform maintenance steps remotely or allow authorized users to download raw data files directly from the receiver.
- Automatic email notifications informing the administrator of possible malfunctions in real time.
- High degree of flexibility inherited from the ProFlex 800 receiver. In addition to delivering raw data files in ATOM or Rinex format, the ProFlex 800 CORS can deliver simultaneously real-time RTK corrections in ATOM (configurable), RTCM2.3, RTCM 3.0 & 3.1 or CMR format through various means:
 - As an IP server or client delivering different streams of raw data through up to nine virtual IP ports (**Ethernet data streaming**).
 - As an “**NTRIP Server**”, delivering its corrections to the embedded NTRIP caster (firmware option) or to an external or third-party NTRIP caster. Up to two independent NTRIP servers can be set up in the ProFlex 800 CORS.
 - Through Direct IP
 - Through a UHF radio link
 - Through its built-in GSM modem.

Hardware Description



System Components Overview

The tables below provide an overview of the different key items composing the ProFlex 800 CORS.

Depending on your purchase, you may only have some of the listed items. Please refer to the packing list for an accurate description of the equipment that has been delivered to you. Ashtech reserves the right to make changes to the items listed below without prior notice.

Basic Supply

Item	Part Number	Picture
ProFlex 800 CORS receiver with all the accessories listed below.	990627	
Cellular antenna (quad-band)	111397	
Bluetooth antenna	111403	
7.4 V-4.4 Ah Li-ion Battery Pack (rechargeable)	111374	
USB Host-to-Device Cable, 0.2 m Makes ProFlex 800 a USB device.	702104	
Ethernet adaptor cable	702426	
Serial data cable	700461	
Multi-function cable, 7C circular connector, bare wires, length: 3 m approx.	702450	
Soft transport bag	206410	

Item	Part Number	Picture
AC/DC Power Supply Kit (includes external AC adapter, battery charger and cable extension for powering ProFlex 800 directly from the AC adapter)	802064	
ProFlex 800 User Documentation CD	501510	

Optional Accessories

Item	Part Number	Picture
L1/L2 GNSS Antenna	111406	
Choke ring installation kit for GNSS antenna P/N 111406	802093	
Choke ring GNSS antenna, 38 dB, 4.2-15 V DC, includes "antibird" radome	111584	
Choke ring antenna bundle, includes the following part numbers: • 111584 (choke ring) • 702455 (coaxial cable) • + N-male / TNC-female adaptor	802120	
Low-loss LMR-240GPS/GNSS cable, 30 meters, TNC male / TNC male	702455	
TNC/TNC coaxial cable, 10 meters	700439	

Equipment Description & Basic Functions

Front View



From left to right:

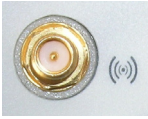

Bluetooth Antenna. A coaxial female connector (reverse SMA type) allowing you to connect a Bluetooth antenna for wireless communication with a field terminal or other device.



Cellular Antenna. A coaxial female connector (SMA type) allowing you to connect a cellular antenna. A cellular antenna is required when the ProFlex 800 sends or receives RTK or differential corrections data via its internal cellular modem (GSM).

Take care not to swap the Bluetooth antenna and the cellular antenna. The picture below shows where the shorter and longer antennas should be connected.





USB Host & Device. A nine-contact female connector (Fischer type). Depending on how it is configured, the USB port can be used in two different ways:

1. For a USB host, such as a mass storage device using optional device cable P/N 702104.
2. For a USB device allowing ProFlex 800 to be seen as a disk from the computer connected to this port. In this configuration, files can be transferred between the ProFlex 800's internal memory and the computer using the USB cable provided (P/N 702103).



Display Screen. The display consists of a 128 x 64-pixel, 1.5-inch monochrome yellow screen using organic LED technology (OLED).

Used in conjunction with the Scroll button, the display screen allows you to view different pages of information. See *Display Screens on page 15* for a detailed description of the information available from this screen.

After a few seconds of inactivity (i.e. Scroll button idle), screen luminosity turns from high to low level.



Power button. To turn on the ProFlex 800, hold the Power button pressed until the power LED lights up.

To turn off the ProFlex 800, hold the Power button pressed until the “Ashtech” screen is displayed. Then release the button and wait until the ProFlex 800 shuts down.



Power LED. • This indicator light is off when the ProFlex 800 is off and no external power source is connected to the DC power input.

- It is on and red when an external power source is present at the DC power input and the ProFlex 800 is off.
- It is on and green when the ProFlex 800 is on, regardless of whether it is powered from the internal battery or an external power source.
- It is blinking red when the sleep mode has been enabled and the receiver is currently running a session. With the sleep mode enabled, the receiver is idle between any two sessions, as if it were virtually turned off, and the power LED is also turned off during this time.



Log Button. Press this button briefly to start recording raw data on the selected storage medium.

Another short press on this button will immediately stop raw data recording.



Scroll button. Press this button briefly to scroll through the different pages of information viewed on the screen.

If an alarm is reported on the display screen, a short press on the Scroll button will acknowledge the alarm. The Scroll button will recover its display scrolling function only after all the alarms have been acknowledged this way.

Another function of the Scroll button is to re-activate the screen backlight after the latter has automatically been turned off. The Scroll button is also used in the firmware update procedure.

Rear View

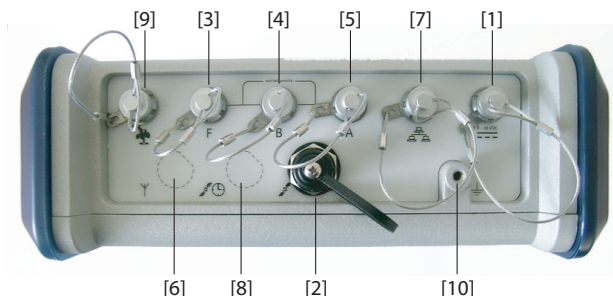

DC Power Input. A Fischer, three-contact, female connector [1] allowing the ProFlex 800 to be powered from either the provided AC adapter (connect the cable extension between ProFlex 800 and the end of the AC adapter output cable), or an external 9- to 36-V DC power source through cable P/N 730477 (cf. base setup using an external radio transmitter).



GNSS Input #1 . A TNC coaxial female connector [2] allowing you to connect a GNSS antenna to the receiver via a coaxial cable.





Serial Data Ports. These are all Fischer, seven-contact, female connectors, each allowing a serial connection to an external device.

- Ports F [3] and B [4] are both RS232-only ports
- RS232/422 Port A [5] is a switchable RS232/RS422 port (Default is RS232).

As an option (installed at the factory), port A also delivers a regulated DC power voltage between pin 1 (+12 V DC) and pin 2 (GND) that can be used to power a connected device. The DC current available is 0.5 A steady state, and 1.0 A peak.

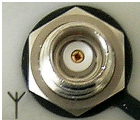

UHF Input. A TNC coaxial female connector [6] allowing you to connect a radio whip antenna. This connector is available only if the ProFlex 800 has been fitted with a radio module. (Connector [6] is missing from the rear view above.)

Warning! Do not confuse this coaxial input with the GNSS input [2] below. Connecting a GNSS antenna to the UHF input might damage it if the embedded UHF transmitter is used (although the transmitter is not supposed to transmit until there are enough GNSS satellites received).



Ethernet Port. A Fischer, seven-contact female connector [7] allowing you to connect the ProFlex 800 to a local network (LAN). Through this connector, you may remotely control and monitor the ProFlex 800 from any computer connected to the Internet. Data may also flow through this port, in the same way as through a serial port.

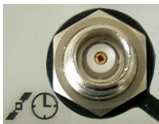

GNSS Input #2. A TNC coaxial female connector [8] for applying an external reference clock. (Connector [8] is missing on the rear view above.)



CAN 2.0 Bus. A Fischer, five-contact, female connector [9] allowing you to connect the ProFlex 800 to external, NMEA2000-compatible equipment via CAN bus. (For future use.)

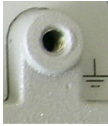

Earth Terminal. A screw terminal [10] for connecting the receiver chassis to Earth.



Electric Isolation. All signals available on the following connectors are optically isolated from the receiver's internal circuitry and chassis ground, as well as from each other:

- Serial ports A, B and F (including DC power output voltage on port A)
- Ethernet port
- CAN bus

Buzzer

The internal buzzer will sound whenever an error is detected. The buzzer will sound six times and then stop. The error icon will however continue to blink. To acknowledge the error notification, first press the Scroll key to view the error and associated code and then press the same button again.

Battery Model & Battery Compartment



The battery used is a 7.4-V DC - 4600 mAh rechargeable battery. It is a standard model used in many camcorders.

The battery is housed in a battery compartment accessible from above the ProFlex 800. The compartment door can be opened by lifting and then turning the quarter-turn finger screw counter-clockwise.

The battery will automatically operate as a backup power source for the receiver if for some reason the external DC power source used is removed from the DC power input.

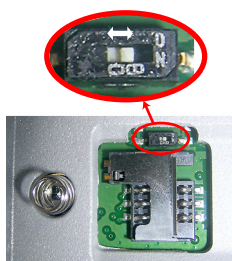

A slide switch is available at the bottom of the battery compartment to set the behavior of the receiver after removal or failure of the DC power source while the receiver is on:

- Slide switch pushed **to the right**: Automatic re-start. The receiver will automatically be switched on when DC power is restored. This is the typically the setting that should be used with ProFlex 800 CORS.
- Slide switch pushed **to the left**: Manual re-start. After power is restored, the receiver will stay off. Operator intervention is needed to switch the receiver back on.

Use for example the tip of a pen to slide the switch to the left or right.

Special Button Combinations

- With the ProFlex 800 OFF, pressing the Power, Log and Scroll buttons simultaneously for a few seconds will restore all the factory settings.
- With the ProFlex 800 OFF and a USB key connected, pressing the Power and Scroll buttons simultaneously for a few seconds will cause the ProFlex 800 to start a firmware upload process. If there is no USB key connected or the key does not contain a firmware upgrade, then the process will abort after a few seconds. Because data has to be decompressed on the USB key during upgrades, the USB key must be unlocked, with at least 100 MBytes of free memory, before starting the upgrade.

These button combinations are summarized in the table below:

Button Combination	ProFlex 800 State	Function
Power+Log+Scroll	OFF	Restores Factory Settings.
Power+Scroll	OFF	Initiates firmware update from USB key.

Charging Batteries Before Use

For a ProFlex 800 CORS, inserting a fully charged battery into the receiver will guarantee that the station can keep operating

for several hours after a power shutdown, giving you the time to take the necessary maintenance steps.

Follow the instructions below to charge a battery.

Removing the Battery from the ProFlex 800

Unless the battery has already been taken out, do the following:

- Open the battery trapdoor, accessible from above the ProFlex 800, by lifting and then turning the quarter-turn finger screw anticlockwise. This releases the two springs located under the battery, pushing the battery slightly upward (see picture).



- Grab the battery and take it out of the compartment.

Charging the Battery

The battery charger comes with a separate universal AC adapter fitted with a 1.5-m output cable. The AC adapter includes a choice of four different, detachable plug types. Follow the instructions below to operate the charger.

- Choose the plug type that is suitable for your country.
- Secure that plug on the AC adapter.
- Connect the cable from the AC adapter to the battery charger.
- Give the battery the right orientation with respect to the charger **[1]** (the battery terminals should come into contact with the two sets of connectors on the charger), then push the battery against the plate and slide it forward **[2]** until it locks into place.

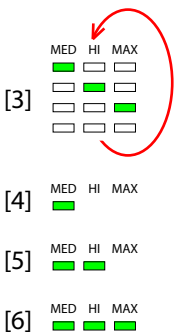

- Plug the adapter into an AC outlet. Battery charging starts immediately.
For a low battery that's being charged, you will first see the three LEDs switch on and off, one after the other, followed by a short period of time when none of the LEDs is on (see [3]).
After about two hours of charging, the MED LED will stay on [4]. A few minutes later, the HI LED [5], and then the MAX LED [6] will also stay on.
- When the three LEDs are on, this means the battery is fully charged and can be disconnected from the charger.

Inserting the Battery in the ProFlex 800

- Insert the battery into the compartment making sure the battery has the right orientation (the battery terminals should come into contact with the two sets of connectors located at the bottom of the compartment).
- Close the trapdoor, push the finger screw in tight, and turn it fully clockwise.

Note that once it is properly secured, the trapdoor pushes the battery against the bottom of the compartment to ensure electrical connection of the battery to the ProFlex 800.

Display Screens

If you press the Scroll button several times, you will see the following displays successively.

Power-On Screen

When you power on the receiver, the Ashtech logo appears on the screen. It is displayed until the receiver has completed its auto-test (this takes about 30 seconds).



Then the General Status screen is displayed.

General Status Screen

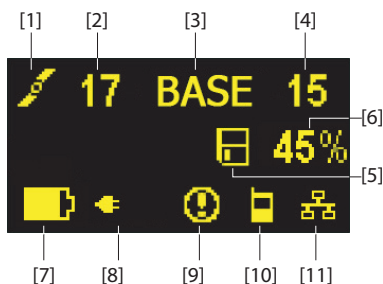

An example of General Status screen is shown below.





This screen displays the following information:

- : Satellite icon [1] (always displayed).
- Number of satellites tracked [2].
- BASE [3]: A label indicating that the receiver is used as a base.
- Number of satellites used [4]: Number of satellites processed by the reference station and for which corrections are made available to users. These satellites are also used to compute an SDGPS solution of the base position. This solution is permanently available on the position computation screen (see *Position Computation Screen on page 16*).

- Raw data logging icon [5]:

	Data recording through front panel Log button or using Recording submenu in the Web Server: – Blinking: Raw data logging in progress – Fixed: No raw data logging in progress.
	Data recording through sessions: – Blinking: Raw data logging in progress – Fixed: No raw data logging in progress.
	ATL data recording for advanced diagnosis.

- Percentage of free memory in the storage medium used [6].
- : Battery icon [7] with visual indication of remaining charge. If an external power source is used (AC adapter or external battery), the battery icon will be animated to indicate battery charging in progress.

 is displayed when there is no battery in the compartment and the receiver is operated from an external power source.

- Power status [8].



Icon	Definition
Percent value	Percentage of remaining battery. This indication will flash when the remaining energy drops below 5%. When an internal battery is used with external power applied, this icon alternates between the plug and the percentage of charge on the battery.
	Replaces percentage when an external power source is used.

- Alarm status [9].





Icon	Definition
	Alarm detected. Press the Scroll button to view the alarm type. Press it again to acknowledge the alarm, which then disappears from the list. Unless there is another alarm in the queue, in which case you will have to resume the acknowledge sequence, the screen then displays the memory screens.
None	No alarm detected

- GSM module (modem) status [10]. This may be one of the following icons:

Icon	Definition
Blank	Modem turned off.

Icon	Definition
	Blinking icon: Modem turned on but not initialized yet. Indicates signal strength at modem antenna input.
	Fixed icon: Modem turned on and initialized (ready for a connection). Indicates signal strength received at modem antenna input. The higher the number of bars, the better the signal.
	Modem on line.

- [11]: USB status and/or Bluetooth status and/or Ethernet port status.

Icon	Definition
	USB port connected to active device
	Bluetooth active
	Ethernet port active
	These two icons will appear successively when both the USB port and Bluetooth are active.
	These three icons will appear successively when the USB port, the Ethernet port and Bluetooth are all active.
Blank	USB port unconnected and Bluetooth inactive.
Blank	USB port unconnected, Bluetooth and Ethernet inactive.

Memory Screens

From the General Status screen, press the Scroll button to access the Memory screens. Memory screens appear successively (see examples) at a display rate of about five seconds:

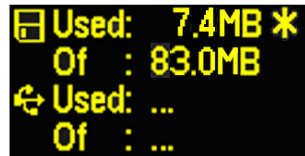
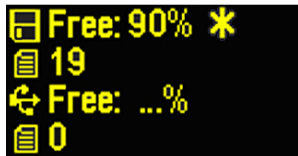

Left screen:

- First line: Percentage of free space in the internal memory.
- Second line: Number of files currently stored in the internal memory.

- Third line: Percentage of free space on the USB mass storage device.
- Fourth line: Number of files currently stored on the USB mass storage device.

Right screen:

- First line: Total space occupied by the files currently stored in the internal memory.
- Second line: Nominal size of the internal memory.
- Third line: Total space occupied by the files currently stored on the USB mass storage device.
- Fourth line: Nominal size of the USB mass storage device.

About the “*” symbol:

- It can only appear at the end of the first or third line.
- Where placed, it indicates that this storage medium is used for data logging.

What if there is no USB mass storage device connected to the receiver?

- Parameters relevant to the USB key size and space used and available are void (three dots displayed instead).
- Number of files is forced to “0”.

Receiver Identification Screen

From any of the two Memory screens, press the Scroll button to access the Receiver Identification screen. See example below.

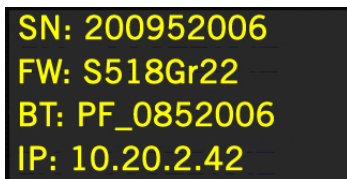

SN: 200952006
 FW: S518Gr22
 BT: PF_0852006
 IP: 10.20.2.42

- Receiver Serial Number
- Firmware Version
- Receiver Bluetooth Identifier
- IP Address

Position Computation Screen

From the Receiver Identification screen, press the Scroll button to access the Position Computation screen. This screen displays the latitude, longitude and ellipsoidal height

of the reference position assigned to the base (not a computed position). See example below.



The upper line contains the same information as in the upper line of the General Status screen.

A new press on the Scroll button will take you to the ATL Recording screen (see below).

ATL Recording Screen

Pressing the Scroll button from the Position Computation screen will take you to the ATL Recording screen, which looks like one of the following, depending on whether a USB key is connected to the receiver (below, right) or not (below, left).

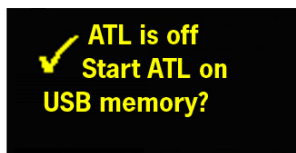
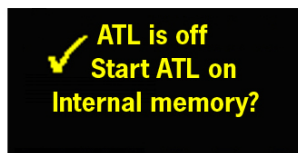

You don't normally have to record ATL data, but if for troubleshooting purposes, the Technical Support asks you to do so, then proceed as follows:

- Press the Log button (left-hand button). This will cause the receiver to start recording ATL data on the specified storage medium. The screen will then look like this:

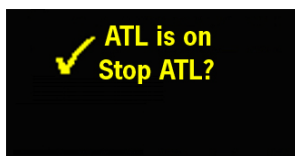

You can then freely use the Scroll button to access other receiver screens without affecting the ATL data collection in progress (pressing the Scroll button from this screen will take you back to the General Status screen).

- When enough ATL data have been recorded (Tech Support will usually indicate the duration of ATL data collection needed for troubleshooting), then come back to the ATL Recording screen and simply press on the Log button again to stop the recording.

NOTE 1: ATL data recording is totally independent of raw data recording: controlling ATL recording is done exclusively from the ATL recording screen, and raw data recording from any other screen.

NOTE 2: Before connecting a USB key to record ATL data, make sure there is no *.par files saved on the key as the presence of this type of file would initiate some other functions in the receiver.

Screen Backlight

The screen backlight is automatically turned off if no key is pressed for 1 minute. When the backlight is off, a short press on the Scroll button will turn it back on. The Scroll button will then recover its usual functions.

Data Transfer Screen

For more information on the screen displayed when downloading files, refer to the *ProFlex 800 Reference Manual*.

How to Safely Power the ProFlex 800 CORS

The setup below is recommended to power the ProFlex 800 CORS as it provides efficient protection from possible power cuts. The slide switch located in the battery compartment should be set to ON (pushed to the right) to make sure the receiver will start automatically after a power shutdown.

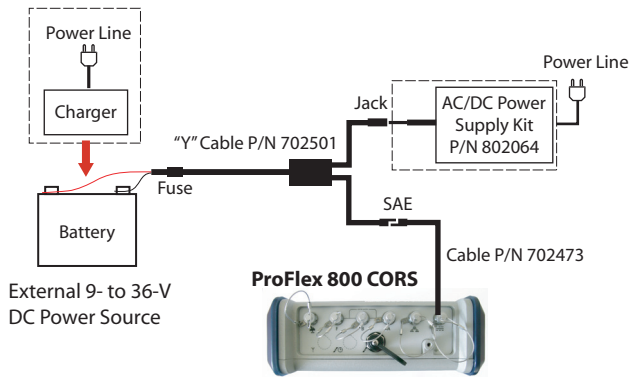

Note that the battery used will not be charged from the AC/DC supply kit. You will need a specific, separate charger for this purpose.

The ProFlex 800 CORS can still use its internal battery in this configuration to extend the operating time in case of persisting power cuts.

Introduction to ProFlex 800 CORS Configuration

Introductory Notes

This section more particularly focuses on how to successfully configure the ProFlex 800 CORS using the ProFlex Web Server. A few status screens are also presented.

It is assumed that you have all the information needed¹ to perform an IP connection from your computer to the ProFlex 800 CORS. This also implies that the Ethernet port is used on the receiver side, and you can run the receiver's embedded *ProFlex Web Server* from a web browser (Microsoft Internet Explorer, Mozilla FireFox, etc.) installed on your computer.

Note: If you need more information about how to make an IP connection to the receiver and run the Web Server from a local or remote computer, please refer to the ProFlex 800 Reference Manual. The ProFlex 800 Reference Manual also includes an exhaustive description of the status screens.

The specific functions expected from a CORS station such as the ProFlex 800 CORS are to generate, convert, sort and distribute raw data files of preset duration (typically one hour). Raw data files may be delivered in native (ATOM) or Rinex format and also include meteo/tilt data from external sensors connected to the station.

Typically, raw data files are made available to users via an FTP server to which ProFlex 800 CORS automatically pushes the files as they are created. A second server can be set up as a backup FTP server.

While ensuring these primary functions, and like any Ashtech ProFlex 800 base, the ProFlex 800 CORS station can also provide real-time RTK corrections in different formats (ATOM, RTCM, CMR, DBEN) and through different means (Internet, radio, GSM modem), including the embedded NTRIP caster. The different steps to learn how to configure a ProFlex 800 CORS station using the ProFlex Web Server may therefore be summarized as follows:

1. First steps with the ProFlex Web Server: Opening the ProFlex Web Server **Home** page to read the information identifying the receiver your computer is connected to. Then opening the **Status** tab to read receiver status information on the ever displayed **Status bar**.

1. CORS station IP address, administrator login and password.

2. Opening the **Configuration** tab to enter the general settings common to any base or reference station.
3. Still on the **Configuration** tab, entering the settings specific to the ProFlex 800 CORS. Before doing that, we encourage you to read the following topics:
 - Creating sessions
 - Raw data types and files collected during sessions
 - Storing G-files collected during sessions
 - Converting/deleting G-files collected during sessions
 - Moving files originating from sessions
 - Pushing files originating from sessions to an external FTP server
 - Recording raw data outside of any sessions
 - Embedded NTRIP caster
 - E-mail notifications
 - Embedded FTP server
 - External sensors.
4. Setting ProFlex 800 CORS to also deliver real-time RTK corrections.
5. Reading a few Status pages to check that the ProFlex 800 CORS is operating as expected.

The last two sections of this manual provide a detailed description of these five configuration steps.

Creating Sessions

Sessions are periods of time in a day during which you want automatic raw data recording to take place.

In parallel, the receiver can be configured to be powered down automatically at the end of each session (sleep mode). It will wake up automatically just before the next session starts. However, the receiver will actually go to sleep mode only if there is enough idle time between your sessions.

Up to 96 sessions can be created per day.

Sessions are repeated every day.

The duration of a session will determine the period of time covered by the raw data file recorded during that session. For example, a one-hour session will result in a one-hour raw data file.

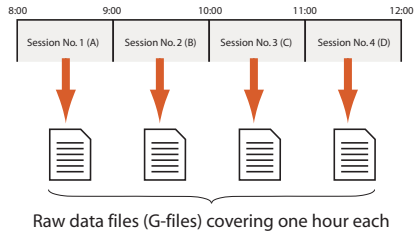

Sessions can be created either automatically (in this case they are all of the same duration), or created individually through a manual procedure.

The two methods can be combined. For example, sessions can first be created automatically and then adjusted manually and individually, if necessary. The following parameters can be edited for each session individually: session start and end times, recording interval and data recording control. No session overlapping is allowed. Doing so would trigger an alarm.

Creating sessions spanning over 24 hours gives a station operating round the clock.

Sessions are numbered from 1 to 96 max. Each session has a session ID. Session IDs are assigned as follows:

- Sessions No. 1 to No. 24: A-X
- Sessions No. 25 to No. 48: AA-XA
- Sessions No. 49 to No. 72: AB-XB
- Sessions No. 73 to No. 96: AC-XC

Note: Data recording can also take place out of any sessions through the ProFlex Web Server's Recording function.

Two additional options are available that may affect the way the programmed sessions are executed:

- **Reference Day (1-366):** This is the day when the execution of the programmed sessions should start. This option should be used when you want your station to start executing its sessions only several days after having configured the station.

The principle is the following: If the current day is prior to the **Reference Day**, the station will wait until that day before starting executing the sessions. If it is after, the station will be allowed to start the sessions on the current day, according to the programmed sessions.

For example, with **Reference Day**=33 (Feb 2), if the current day is 30 (Jan 30), the station will start the first session only in three days, whereas if the current day is 51 (Feb 20), the station will start the programmed sessions on that day.

If you do not need to postpone the execution of the sessions, keep the default value (1) for this option.

- **Offset per Day** (in minutes and seconds): This option is specifically designed for users who wish to have the same sky view of the GPS constellation every day. As the time when the GPS constellation comes back to a given sky view happens 4 minutes earlier every day, setting this option to 04'00" will correct for this offset (i.e. this will allow the same GPS sky view to be observed every day through the same session).

With **Offset per Day**=4'00", a session initially set to start at 9:00 for example will start at 8:56 on the second day, at 8:52 on the third day, etc. The same rule applies to the session end time, and to all the other programmed sessions.

If you do not need to offset the sessions, keep the default value (0'00") for this option.

Raw Data Types and Files Collected During Sessions

The type of raw data collected during sessions are all those you have set on the **R port**. In addition, the amount of the raw data collected is tied to the elevation of the satellites tracked (**Recording Elevation Mask**).

Raw data are saved as *G-files*, using the same naming convention as the one used in manual recording. A specific **Site Name** can be defined for files recorded through sessions. The file naming convention used is recalled below:

G<SiteName><Index><Year>.<Day>

Example: GPT12C10.30 is the third G file generated on Jan 30, 2010 on a site named PT12.

Storing G-Files Collected During Sessions

G-files are saved either in the receiver's internal memory or on a USB device, i.e. on the mass storage device connected to the receiver via its USB port. With this last option used, a really huge amount of memory can be associated with the receiver. In both cases, G-files are all indistinctly saved in the root directory of the selected storage device.

At this stage, special mention should be made of the **Ring File Memory**. With this option activated, the reference station will be able to collect data for an unlimited period of time without external intervention. In practice, this option will allow the

receiver to automatically delete the oldest G-file when the amount of available free memory (in the selected storage device) falls below 15 Mbytes.

Converting/ Deleting G-Files Collected During Sessions

G-files can be converted to Rinex 2.11 or 3.01, with or without the Hatanaka option. This will happen only if ATOM navigation data are included in the G-file (the conversion will otherwise fail).

The receiver can automatically complete the RINEX file header while converting G-files to RINEX files. The fixed additional information you would like the receiver to insert into that header can be entered using **Sessions > Settings** on the ProFlex Web Server.

The recording rate for RINEX files may be different from the one used to collect the original G-files. It cannot however be less than 1 second.

A second RINEX file may be generated in parallel to the first one, possibly with a different rate. This file will be stored automatically in a subfolder named:

“data_<rate_in_seconds>”.

If G-files are converted to Rinex, the resulting files can in addition be zipped in TarZ format.

The file conversion/compression may be followed by the deletion of the original G-file, if desired.

Moving Files Originating from Sessions

The collected G-files and converted files may be moved to another location on the receiver. The purpose is to be able to sort the files according to the date of creation and the site of data collection.

The storage medium used in the File Move function may be different from the one initially used to store G-files. For example, the receiver may be asked to store the original G-files in its internal memory and then you can ask that the G-files and converted files be moved to the USB device.

When doing that, the receiver will automatically create subdirectories according to the rules you will have specified earlier. Typically, the receiver may create this type of tree structure as new files are collected:

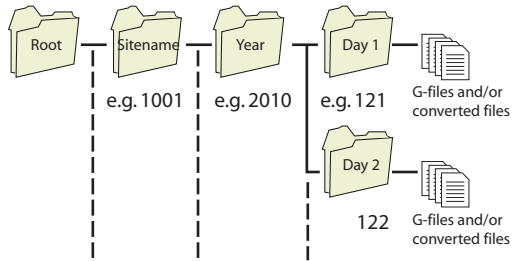

Organizing the storage of the files is simply obtained by typing the appropriate codification of the subdirectories in the field named **Sub-directory Name Format**. This field uses a specific syntax with case-sensitive characters. A typical syntax used is the following:

S/Y/D

Where each letter tells the receiver in which order to create the subdirectories and how to name them (see table below).

Character	Description
s or S	4-character sitename
Y	4-digit year (2010= 2010)
y	2-digit year (10= 2010)
m	2-digit month (01= January)
M	3-character month (Jan= January)
d	2-digit day in month (1-31)
D	3-digit day in year (1-365)

Pushing Files Originating from Sessions to an External FTP Server - Backup FTP Server

Parallel with the File Move function, the converted files may be pushed automatically to an external FTP server through an IP connection, using the FTP communication protocol (activate the **Automatic Transfer** option).

End users will then be able to connect to that FTP server (primary FTP server) for downloading the data they need for their applications.

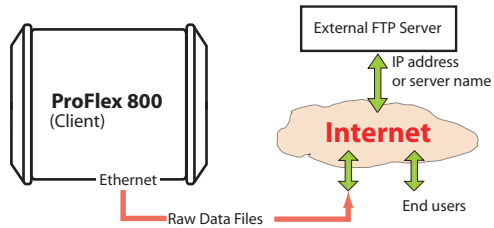

The reference station being the client for this transfer, you need to enter the IP address (or host name) and IP port of the remote FTP server, and also enter the login and password that will let the receiver upload its files to the server without any problem.

You can also sort the files while transferring them to the FTP server. This is done using the same method as in the Move File function (a dedicated **Sub-directory Name Format** field also exists in this case of use).

By default the created tree structure is attached to the root directory of the FTP server. Using the **Path** field, you can attach the tree structure to the subdirectory the FTP server owner will have assigned to you. For example, typing **Path=** CORS5212 or **Path=** /CORS5212/ (the first and last slashes are optional), means your subdirectories will be created in the CORS5212 subdirectory.

You can ask the receiver to delete the files from the receiver after it has pushed them to the external FTP server. This is achieved by enabling the **Delete Files After Transfer** option.

To make sure the files are always available to users, a backup FTP server can be made ready. The backup FTP server will use the same file organization as the one defined for the primary FTP server (through the above-mentioned **Sub-directory Name Format** field). The backup FTP server can be used in two different ways:

- Temporarily, following a failure of the primary FTP server. The backup FTP server will then instantly take over the role of the primary FTP server.

At the beginning of each new session, the ProFlex 800 CORS checks to see if the primary FTP server is back to work and accessible. If that is the case, files will be pushed back to the primary FTP server (and the backup FTP server will stay idle in the background).

- Permanently, as a second repository for all the files collected by the CORS station.

Recording Raw Data Outside of Any Sessions

Raw data recording can also take place outside of any sessions. What's more, it can take place simultaneously with data recording performed through the programmed sessions. This alternate recording capability can be controlled through the **Configuration - Recording** submenu in the ProFlex Web Server.

Like with sessions, this type of data recording produces a G-file but the recorded data are those set on the port corresponding to the storage medium used (and not on port R). If for example the internal memory is used to save the G-file, then the recorded data will be those set on port M.

The settings are very similar to, while independent of, those found for sessions (i.e. sitename, recording elevation mask, observation mask, recording interval). For example raw data can be collected at 1 Hz through sessions while those collected through the Recording function may be at 20 Hz. Also a different site name may be used so that you can easily identify those generated through the Recording function from those generated through sessions.

When logging raw data using the Recording function, the duration of the raw data files is controlled by the **Split Data into Preset Duration Files** parameter:

- If it's disabled, a single raw data file will be created with unlimited duration and size.
- If it's enabled and a duration is selected, the receiver will create as many files as necessary, all of them being of the requested duration.

As with sessions, the **Ring File Memory** option may be used in this case to manage the free memory space. When there's only 15 Mbytes left in memory, the older raw data file will be deleted to keep the level of free memory at around 15 Mbytes. Note that when activated, the **Ring File Memory** option applies to both the Recording and Sessions functions.

NOTE: This function only exists as a \$PASHS command (\$PASHS,RFB). Activating this function will make inaccessible the **Split Data into Preset Duration Files** parameter on the Web Server.

Embedded NTRIP Caster

Introduction

The *Embedded NTRIP Caster* allows you to build your own NTRIP network solution around the ProFlex 800 CORS station.

The embedded NTRIP caster can handle a total of 100 users and 10 mount points. The number of 100 users should be understood at the total number of possible users, irrespective of the mount points they are using. For example, if 90 users are connected to mount point n , then only a total of 10 users can be connected to any of the other mount points.

One of the distinguishing features of ProFlex 800 CORS is its capacity to accommodate internally two NTRIP servers directly “feeding” the embedded NTRIP caster. The other NTRIP servers, if any (up to 8), will therefore be all external to the ProFlex 800 CORS.

- The two internal NTRIP servers will both provide correction data from the “base” section of the ProFlex 800 CORS (see figure below), typically in different formats.
- *Internal NTRIP server 1* uses Ethernet port P to deliver its correction data to the caster. The correction data are internally routed from the base either through the internal modem or directly via Ethernet.
- *Internal NTRIP server 2* uses Ethernet port Q to deliver its correction data to the caster. The correction data can only be routed internally from the base via Ethernet.

The figure below shows the internal architecture of the ProFlex 800 CORS when the *Embedded NTRIP Caster* firmware option is enabled and running and two internal NTRIP servers are also set up and running.

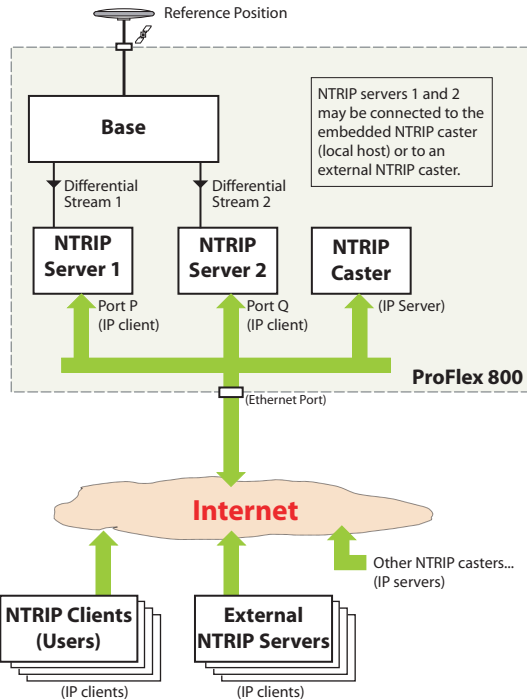

In its simplest configuration, the embedded NTRIP caster can be used to emulate the Direct IP mode (i.e. IP connection to a unique source of corrections), with the additional advantage that, contrary to conventional Direct IP, the embedded NTRIP caster can offer an effective protection of the source of corrections by restricting its use to the sole authorized users.

In this application, the ProFlex 800 CORS makes use of both its embedded NTRIP caster and an internal NTRIP server (see figure below):

- In the NTRIP caster, a single mount point is available and all declared users are allowed to use this mount point.
- The internal NTRIP server is connected to the NTRIP caster's unique mount point.

The result is that only the NTRIP caster users are allowed to use the source of corrections.

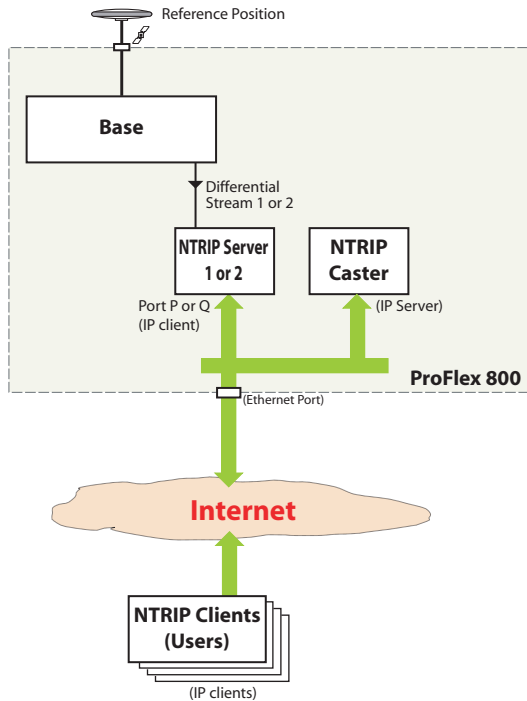

NTRIP Caster Control & Monitoring

The ProFlex Web Server provides an easy way to remote control and monitor the Embedded NTRIP caster.

Once the Embedded NTRIP Caster firmware option has been activated in the receiver, the Web Server shows the **Embedded NTRIP Caster** option both in the Status and Configuration menus.

On the Configuration menu, the **Embedded NTRIP caster** option is split into three submenus:

- The **Settings** submenu allows you to control the NTRIP caster function (ON/OFF), declare the public IP address of the caster, specify the unique password that all NTRIP servers will need to provide if they want to be authorized as a recognized source of corrections for the caster, and the maximum number of simultaneous connections accepted per user (default: 1). The submenu also allows you to provide all the informative data usually found in an NTRIP source table (this information is forwarded to users when querying the NTRIP caster).

- The **Mount Points** submenu allows you to define each of the possible 10 mount points of the NTRIP caster. Choosing the name of a mount point is important:
 - it is through that name that NTRIP servers can connect to the NTRIP caster.
 - it is through that name that users can choose which base station they want to receive correction data from.

Informative data for each mount point can also be defined on this submenu, such as the approximate position of the base that will provide correction data through this mount point, the country where it's located, and whether using the data from this base is free or not.

Each mount point definition appears in the table at the bottom of the page. You can easily modify each of them by selecting the corresponding row in the table.

- The **Users** submenu allows you to define all the possible users of the NTRIP caster. Defining a new user includes specifying a user name and password, as well as the allowed mount points. Refer to *Protecting Mount Points on page 32* for more information on the impact of explicitly assigning mount points to users.

Each user definition appears in the table at the bottom of the page. You can easily modify each of them by selecting the corresponding row in the table.

On the Status menu, the **Embedded NTRIP caster** option is split into three submenus:

- The **Current** submenu provides the list of mount points through which sources of correction data are currently available, as well as the list of currently connected users. Each user is clearly identified (name, mount point used, time when connection started, IP address).
- The **History** submenu provides the same type of information as the **Current** submenu, with in addition the list of past connections (start and end times, users, mount points, IP addresses) since the NTRIP caster was started. It is in fact a more friendly way of representing the content of the log file presented below.
- The **Log** submenu views the raw content of the log file gathering all the events in relation with the embedded NTRIP caster since it was started.

Map

The Web Server provides a map of the NTRIP caster network using different colors to show the location of the caster, of the NTRIP servers (bases) and of the different users.

Protecting Mount Points

Protecting mount points may be done in an indirect way, as explained below:

- Not assigning a mount point to any of the declared users implies that this mount point is accessible to anyone who can make an Internet connection to the NTRIP caster. Besides, the NTRIP caster may list mount points that are not declared as managed by the NTRIP caster. If such mount points are available, anyone who can make an Internet connection to the NTRIP caster will be allowed to connect to these mount points.
- Conversely, from the moment a mount point is assigned to a declared user, this mount point is no longer accessible to all. Only declared users explicitly granted the right to connect to that mount point will be able to do so. As the administrator of the NTRIP caster, you can for example create a user for the sole purpose of protecting your mount points. Allowing this user to connect to all your mount points will amount to placing right away a protection on all these mount points, preventing anyone else to connect to them. Then you can gradually add new users allowed to connect to one or more of the protected mount points.
- In order to keep the NTRIP caster accessible to a maximum of declared users, you can limit the number of simultaneous connections allowed per user. Too many simultaneous connections from one user would indeed limit the number of possible connections for all other users.
- **Warning!** Having declared users not assigned to a single mount point means they can access all the mount points managed by the caster!

E-mail Notifications

As the administrator of the CORS reference station, you may be informed via email of possible malfunctions detected by the receiver. This will allow you to quickly respond to the email alert by taking the appropriate maintenance steps.

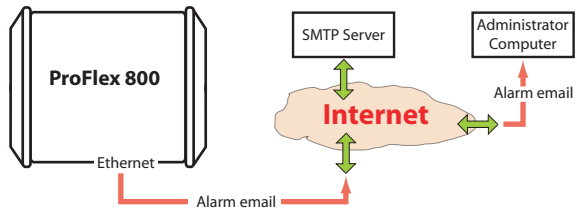

You may choose between three different levels of notification:

- **Full notification.** Each of the following events will generate an email:
 - “High” and “medium” alarms
 - Receiver powered on
 - Power shutdown causing the receiver to operate from its internal battery.
- **Standard notification.** Each of the following events will generate an email:
 - “High” alarms only
 - Receiver powered on
 - Power shutdown causing the receiver to operate from its internal battery.
- **No notification** at all.

Remember the receiver may report three categories of alarms:

- “High” alarms, indicative of serious problems
- “Medium” alarms
- “Low” alarms

The receiver is not designed to process incoming emails. It is therefore no use replying to an alarm email.

Example of email notification:

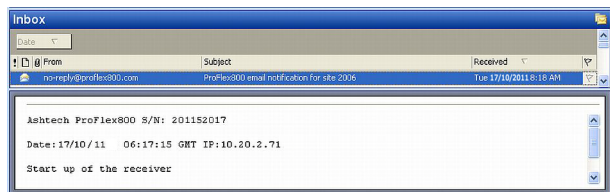

Embedded FTP Server

End users may download raw data files directly from the receiver memory. This can be done through the embedded FTP server, which gives remote access to the selected

receiver memory and directory via an IP connection, using the FTP communication protocol.

In this case, end users should be given read access (through a user profile) to the directory containing the raw data files collected by the receiver.

Alternatively, as the owner of the station, you may have to perform remote maintenance operations in the receiver memory. This connection gives you full read/write control on the specified directory and child directories.

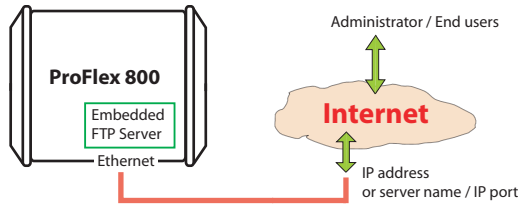

Note that the embedded FTP server gives access only to the specified directory (and its child directories), whether you log in as the administrator or as a user.

External Sensors

The CORS reference station can also be interfaced with external sensors via its serial ports. Typically, this functionality is used to interface the receiver with a tiltmeter or a meteorological station.

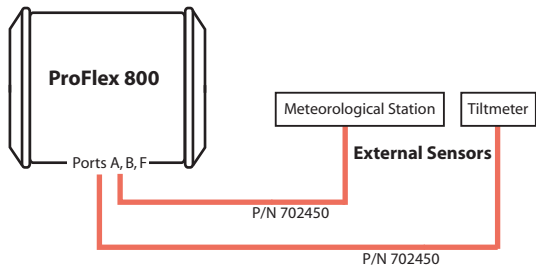

As the administrator, you can ask the receiver to initiate the communication with the external sensors in order to acquire data from these sensors. Initialization and trigger strings may in advance be assigned to the concerned serial ports for this purpose.

The acquired sensor data are inserted into the raw data file (G-file) currently recorded. Optionally the sensor data can

also be saved as a D-files, in which case the D-files are saved in the same subdirectory as the corresponding G-files. Sensor data can also be output through the NMEA XDR message type.

External sensors can be connected to the ProFlex 800 using multi-function serial cable P/N 702450 (3 meters in length). This cable has bare wires at one end, and a circular, seven-contact connector at the other end. The pinout is as shown in the diagram below.

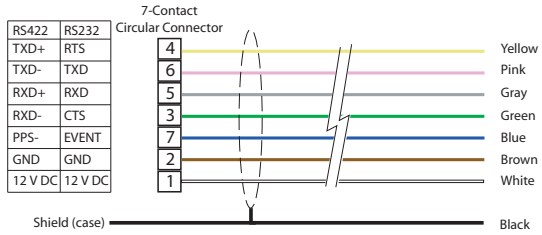

First Steps With the Web Server

Home Tab The Web Server Home tab appears after you have typed the correct IP address in the Address box of your web browser and pressed the Enter key.

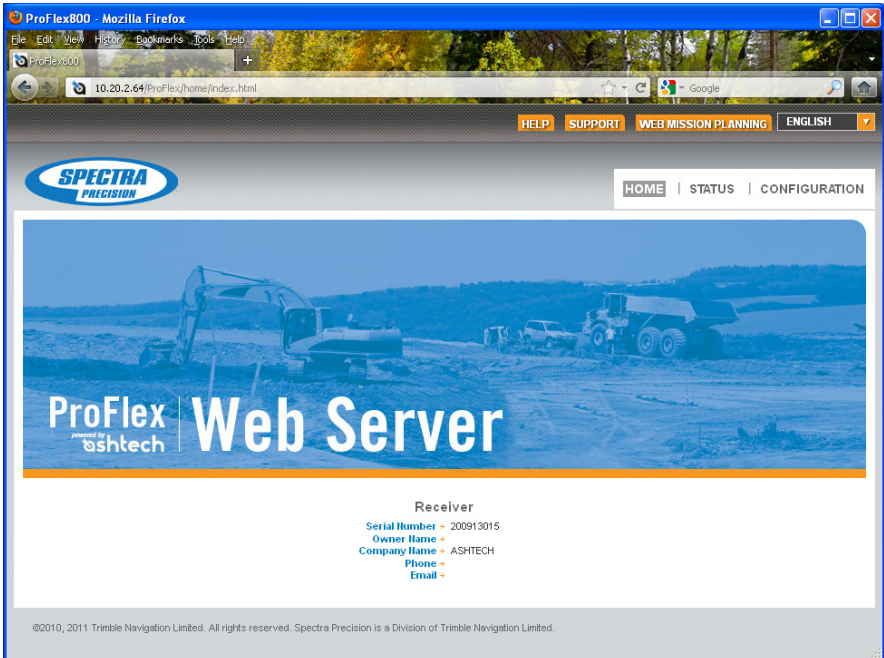

In the right-upper corner of the window, you have access to the on-line help (**HELP** link) and to technical support (**SUPPORT** link).

You can also change the language of the Web Server interface. This will simultaneously change the language of the Help files accessible through the HELP link.

Still from the right-upper corner of this window, you can run Ashtech's Web Mission Planning, a web-based application allowing you to get information on the GNSS constellations visible from a given point on the Earth surface, and for future or past periods of time.

In its lower part, the Home tab lists the parameters that clearly identify the remote receiver. The table below lists all

these parameters. For your information, the third column indicates the relevant \$PASH commands.

Parameter	Designation	\$PASH
Receiver serial number	Hardware-coded receiver serial number	\$PASHQ,RID
Owner name	Owner name	\$PASHS,WEB,OWN
Company name	Name of the company operating the receiver	\$PASHS,WEB,OWN
Phone	Contact phone number	\$PASHS,WEB,OWN
Email	Contact email	\$PASHS,WEB,OWN

(The last four parameters can be changed from the Administrator menu on the Configuration tab.)

Depending on what you want to do with the receiver, click on one of the other two available tabs. Prior authentication as the “Administrator” or a “User” is required before you are allowed to access one of these tabs:

- **Status:** This tab provides detailed information about the current status of the receiver. This is a read-only function. You first need to log in as a “User” or as the “Administrator” before you are given the right to access this tab. When you click on this tab, the Web Server will remember which page was last opened on this tab, and so will display it by default. You can then choose the one you would like to display by clicking in the menu on the left.
- **Configuration:** This tab allows you to make changes to the current configuration of the receiver. You first need to log in as the “Administrator” before you are given the right to access this tab. When you click on this tab, the Web Server will remember which page was last opened on this tab, and so will display it by default. You can then choose the one you would like to display by clicking in the menu on the left.

Status Bar and Units Used

The status bar is permanently displayed in the upper part of the **Status** or **Configuration** tab, giving the current operating status of the receiver. The content of the status bar is refreshed every one to two seconds.

Mode → Rover Lat → 47°17'56.27190"N HRMS → 0.374 m GPS → 8 / 13 Battery → Recording → On Sessions → Recording 2011-11-15
 Position → S-DGPS Long → 01°30'32.54970"W VRMS → 0.480 m GLOHASS → 6 / 9 Modem → Off Site Name → 3015 Site Name → soph 13:06:57
 Station ID → 124 Height → 88.634 m HDOP → 0.8 SBAS → 0 / 2 Level → Memory → M: 16.1 MB Memory → M: 16.1 MB Alarms (1)
 Age → VDOP → 1.3 GALILEO → 0 / 0 ITRIP Caster → Off FTP Push → Off

By column from left to right:

Column #1	
Mode	Receiver operating mode ("Base", "Rover", "Rover/Heading" or "Hot Standby RTK")
Position	Type of position solution currently available from the receiver ("No position", "Autonomous", "DGPS", "S-DGPS", "RTK Fixed" or "RTK Float")
Station ID	<p>If a base:</p> <ul style="list-style-type: none"> • 0 to 4095 for a station transmitting ATOM or RTCM3.x corrections • 0 to 1023 for a station transmitting RTCM2.3 corrections • 0 to 31 for a station transmitting CMR/CMR+ corrections <p>If a rover:</p> <ul style="list-style-type: none"> • Shows the ID of the base station received. • In S-DGPS, shows the ID of the SBAS satellite used.
Age	Age of corrections, in seconds (0 to 999 seconds)
Column #2	
Lat	Latitude of position currently computed by the receiver
Long	Longitude of position currently computed by the receiver
Height	Height of position currently computed by the receiver
Heading	Current heading value measured by the receiver if used in Rover/Heading mode
Column #3	
HRMS	Horizontal Root Mean Square
VRMS	Vertical Root Mean Square
HDOP	Horizontal Dilution of Precision (0 to 9.9)
VDOP	Vertical Dilution of Precision (0 to 9.9)
Column #4	
GPS	Number of GPS satellites used vs. number of tracked GPS satellites
GLONASS	Number of GLONASS satellites used vs. number of tracked GLONASS satellites
SBAS	Number of SBAS satellites used vs. number of tracked SBAS satellites
GALILEO	Number of GALILEO satellites used vs. number of tracked GALILEO satellites
Column #5	
Battery	Percentage of remaining charge in the installed battery
Modem	Modem power status ("Off", "On", "Starting", "Ready", "Dialing", "Online" or "None")
Level	Input signal level (0 to 100, or blank when Modem Status= Online)
NTRIP Caster	"off" or, if "On", number of sources available (S:xx) and number of connected clients (.C:xxx)
Column #6	
Recording	Raw data recording status ("On" or "Off")
Site Name	Site name (4 characters) attached to logged data
Memory	Identification of memory used ("M" for internal, "U" for USB key)+ Number of free Megabytes on this memory.
Column #7	
Sessions	Session status ("ON" "OFF", "RECORDING")
Site Name	Site name (4 characters) attached to data logged through sessions
Memory	Identification of memory used ("M" for internal, "U" for USB key)+ Number of free Megabytes on this memory.

FTP Push	Indicates whether the recorded raw data files are uploaded to an external FTP server ("On") or not ("Off").
Column #8	
Date	Current date (YYYY-MM-DD)
Time	Current local or UTC time (hh:mm:ss) according to the setting below.
Alarm report	Blank area if no alarm has been detected. "Alarms" displayed if an alarm has been detected in the receiver, followed by the number of raised alarms, between brackets (x). A click on "Alarms" will open the Status-Alarms web page to list this or these alarms.

To change the units, select your preference from the **Units** pane on the left-hand side of the Web Server window. This pane is visible in both the **Status** and **Configuration** tabs.



Distance Units

- Meters
- US Survey Feet
- International Feet

Angle Units

The possible formats for angles, including latitudes and longitudes, are the following:

- Degrees (Deg.)
- Degrees, minutes (Deg. Min.)
- Degrees, minutes, seconds (Deg. Min. Sec.)

The format of latitude and longitude depends on the chosen angle unit. The corresponding formats are described in the table below.

Angle Unit Used	Latitude Format	Longitude Format
Deg.	DD.DDDDDDDDD° N or DD.DDDDDDDDD° S	DDD.DDDDDDDDD° E or DDD.DDDDDDDDD° W
Deg. Min.	DD°MM.MMMMMM' N or DD°MM.MMMMMM' S	DDD°MM.MMMMMM' E or DDD°MM.MMMMMM' W

Angle Unit Used	Latitude Format	Longitude Format
Deg. Min.	DD°MM' SS.SSSSS" N or	DDD°MM' SS.SSSSS" E or
Sec.	DD°MM' SS.SSSSS" S	DDD°MM' SS.SSSSS" W

Where:

- N for North, S for South; E for East, W for West
- “D..” for degree digits, “M..” for minute digits, “S..” for second digits

When typing in a latitude or longitude, leading and trailing zeroes can be omitted. Degree (°), minute (') and second (") symbols can be omitted as well.

For example, typing 5 6.45 N is a valid entry for 5° 06.450000' N.

If you use the “Deg.” angle unit, you can use signs for directions:

- “-” sign for South (S) or West (W)
- No sign or “+” sign for North (N) or East (E)

Time Units

Time is always expressed in 24-hour format. You can choose between the following two options:

- UTC: UTC time provided by the receiver.
- Local: Local time derived from the UTC time provided by the receiver, taking into account the time zone read from the computer’s regional settings.

Setting a CORS Reference Station

How to Start

- Open the Web Server's **Configuration** tab. The first time you click on this tab, the Web Server will ask you to log in as the administrator. Only the receiver administrator is authorized to access the **Configuration** tab.
You are allowed to change the destination of a receiver (e.g. it is currently a rover and you want to change it into a base). In this case, on opening the **Base Setup** tab, the Web Server will retain part of the rover settings that could be applied to the base (e.g. antenna type, etc.).
- Programming the data generated by the CORS station is addressed separately (see *Defining the Raw Data Generated by the CORS Station on page 43*).

General Parameters

- Click on the **Base Setup** menu. The **Full Setup** web page opens.
- Set the receiver parameters:
 - **Dynamic:** Choose “Static”.
 - **Moving Position:** Keep this option disabled.
 - **Latitude, Longitude, Ellipsoid Height:** Enter the reference position of the CORS station (three-dimensional geographical coordinates).
(Clicking on the **Get current position** button assigns the last position computed by the receiver to the reference station as its reference position.)
- Set the GNSS antenna parameters:
 - **Reference Position:** Specify the physical point of the CORS station for which the receiver will collect data. The three possible choices are: Antenna L1 phase center, Antenna Reference Point (ARP) or Ground Mark (reference point).
 - **Measurement Type:** Specify the method that was used when setting up the CORS station to measure the height of the GNSS antenna (typically “Vertical” is used, “Slant” being most of the time used for temporary base setups on tripods).
 - **Antenna Height:** Value of base antenna height, expressed in the selected distance unit, as measured according to the specified measurement method.
 - **Receiver Antenna:** Specify the model of GNSS antenna used by the receiver.

- **Antenna Radius:** In case of a “Slant Height” measurement, enter the antenna radius (this is a manufacturer specification), taking care to enter this parameter in the selected distance unit. See also the diagram below for more information.
- **SHMP Offset:** In case of a “Slant Height” measurement, enter the SHMP offset (this is a manufacturer specification) taking care to enter this parameter in the selected distance unit. See also the diagram below for more information.

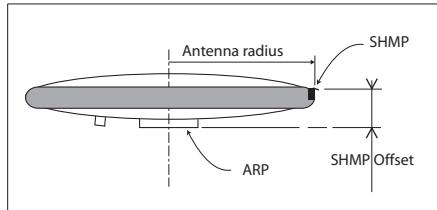

- **Virtual Antenna:** This option is used to emulate a GNSS antenna other than the one really used (typically ADVNULLANTENNA is used).
Choosing a virtual antenna different from the one really used affects the raw and differential data as if they had been collected by the virtual antenna, instead of the real one.
- Set the parameters relevant to the GNSS constellations used by the receiver:
 - **Recording and Output Elevation Mask:** Choose the elevation angle above the horizon creating the desired reception mask. After setting this angle, any satellite seen from the base with an elevation angle less than the specified one will be rejected from the list of usable satellites. The default value is 5°.
 - **GLONASS, SBAS:** In addition to the GPS, you can ask the receiver to track the GLONASS and/or SBAS satellites as well. Enable the options corresponding to the additional constellations you want the receiver to use.
- Click on the **Configure** button to save all the changes made.

Defining the Raw Data Generated by the CORS Station

Click on **Data Output** and then on the **Raw Data** submenu. Use the page that opens as explained below:

- All ATOM and Ashtech legacy raw data message types are listed below.

Format	Message types
ATOM	NAV, PVT, ATR, DAT, EVT, RNX
Ashtech legacy	DPC, SAL, SAG, SAW, SNG, SNV, SNW, ION, SBD, MPC, PBN

(Typically, a G-file should contain NAV, RNX and ATR data to guarantee successful conversion of the file into RINEX files. NAV provides navigation data, RNX observations data, and ATR external sensor data.)

- Follow the instructions below to define the output of ATOM message types:
 - For each ATOM message type you need to define, select it from the **Message** drop-down list, then select the output port (“R - Session” necessarily) from the **Output** drop-down list, then enter its output rate, in seconds, in the **Rate** field, and finally click on the **Add** button. The new message definition will then appear as a new row in the table on the right.
NOTE: You don’t have to define an output rate for EVT and DAT.
 - Should you change the definition of an existing message, select the corresponding row in the table. This populates the fields on the left with the definition of that message. Edit the definition and then click on the **Modify** button to save your changes. The table row is updated accordingly.
Note that depending on the current selection on this page, the button located underneath the fields on the left may be either grayed or with a different label (**Add** or **Modify**).
 - Deleting a message definition can be done by simply clicking on the corresponding “trash” sign in the **Clear** column on the far right. This deletes the table row. There is also a **Clear All** button under the table that allows you to delete all message definitions from the table in one click.
- Follow the same instructions as above to define the output of Ashtech legacy message types. Note that you don’t have to define an output rate for SBD.



Warning! The rates of message types RNX (ATOM message type) and MPC (Ashtech legacy message type) are in fact defined by the **Recording Interval** parameter on the **Sessions - Scheduling** web page (see *Programming Sessions on page 44*). The value you might enter on the **Raw Data** web page for these messages would anyway be ignored. It would even be overwritten with the value given to **Recording Interval** when the first session starts.

- Click on the **Configure** button to save all the changes made. The concatenation of the selected messages will constitute the G-files saved in the receiver (internal memory or USB device).

Programming Sessions

The typical use of sessions in a CORS station consists of defining 24 sessions representing each one-hour data recording at a 1-second recording interval. Follow the instructions below to create these sessions:

- Click on **Sessions - Scheduling**.
- Enter “00:00:00” as the **Start Time**, “1” as the **Recording Interval**, “01:00” as the **Duration** and “24” as the **Number of Sessions**.
- Click on the **Auto Set** button.
- Click on **Back** after the “Successful” message has been returned by the Web Server. You can now see the list of sessions you have just created in the Sessions table:

Scheduling

Auto Configuration

Start Time (hh:mm:ss) UTC Recording Interval
(seconds)

Duration (hh:mm)

Number of Sessions

Auto Set

Manual Configuration

Session ID Use

Start Time (hh:mm:ss) UTC Recording Interval
(seconds)

End Time (hh:mm:ss)

Manual Set

Sessions

Session Number	Session ID	Use	Start Time	End Time	Interval
1	A	<input checked="" type="checkbox"/>	00:00:00	01:00:00	1
2	B	<input checked="" type="checkbox"/>	01:00:00	02:00:00	1
3	C	<input checked="" type="checkbox"/>	02:00:00	03:00:00	1
4	D	<input checked="" type="checkbox"/>	03:00:00	04:00:00	1
5	E	<input checked="" type="checkbox"/>	04:00:00	05:00:00	1
6	F	<input checked="" type="checkbox"/>	05:00:00	06:00:00	1

Clicking in a row inside the table allows you to edit the session individually. The changes are then entered by clicking on the **Manual Set** button

Note that the **Use** button is checked by default, which means data recording is allowed during the session.

Starting Sessions & Managing Raw Data Files

To start the execution of the programmed sessions on the current day, do the following:

- Click on **Sessions - Settings**
- Enable the **Run Sessions** check box.
- Keep default values for **Reference Day** ("1"), **Offset Per Day** ("00:00") and **Recording and Output Elevation Mask** (5°).
- Choose the storage medium. "Internal Memory" is about 95 Mbytes in size. Using an external device connected to the receiver's USB port ("USB Device") may allow the receiver to operate with an even larger memory.

- Check the **Ring File Memory** option. This will result in an unlimited operating time for the station while using a finite memory size.
- **Data Type** recalls the type of raw data collected through sessions.
- You may want to save receiver power between sessions when those are separated by more than 15 minutes of idle time. If so, check the **Power Off.. Between Sessions** button. Remember power will be applied automatically to the receiver 15 minutes before the beginning of the next session.
- In the G-File Conversion pane, choose the desired file conversion scenario (Rinex or Rinex Hatanaka, followed or not by file compression and original file deletion and possible rate change for the RINEX file). You can also ask for a second RINEX file, with specific rate, to be generated as well.
- Using the different fields in the File Move pane, choose whether you want to move the raw data files (original and/or converted files) to another location in the receiver (internal memory or USB device) so they can be at the same time sorted by sitename, year, month and day of creation.

If you wish to do so, you have to specify –in the **Sub-directory Name Format** field– the syntax through which the receiver will be able to create new subdirectories as new raw data files are made available. The syntax may typically be in the form:

S/Y/D

Where each letter tells the receiver in which order to create the subdirectories and how to name them (see table below).

Character	Description
s or S	4-character sitename
Y	4-digit year (2010= 2010)
y	2-digit year (10= 2010)
m	2-digit month (01= January)
M	3-character month (Jan= January)
d	2-digit day in month (1-31)
D	3-digit day in year (1-365)
p or P	data_<d> or DATA_<d>, where <d> is the period in seconds

- Using the different fields in the Transfer to external FTP Server pane, choose whether you want the receiver to automatically transfer the collected raw data files (original and/or converted files) to an external FTP server. If so, activate the **Automatic Transfer** option and enter the identification parameters of the FTP server:
 - **FTP Server, Port:** FTP server IP address/hostname and IP port
 - **Login, Password:** Connection profile that gives the receiver the rights to upload data to the FTP server.
 - **Path:** Location on the FTP server where the receiver is allowed to post the files (syntax: /subdirectory/.../subdirectory/). The first and last slashes are optional.
 - **Sub-directory Name Format** field: Also in this case, files will be sorted by sitename, year, month and day of creation, using the same instructions as previously (File Move) to set this field.

You can also ask the receiver to delete the raw data files once they have been transferred to the FTP server. This is done by enabling the **Delete Files After Transfer** option.

- You may define a second FTP server, called “backup FTP server” for securing the raw data file transfer to an external repository.

In the Backup FTP Server pane, first specify the conditions in which the backup FTP server will be used:

- Never (two buttons cleared)
- Always (**Always Used** button checked)
- Only when the primary FTP server is unable to fulfil its function (**Used When Primary FTP...** button checked)

Then enter the data required for an IP connection to this second FTP server (address, login, password, path; keep the default value “21” for the IP port).

Note that you don’t need to define a folder naming convention for the backup FTP server. The same naming convention as the one defined for the primary FTP will be used (see **Sub-directory Name Format** field above).

- Click on the **Configure** button to save all your settings.

Programming Email Notifications

- Click on **Advanced Setup** and then on the **Email Notifications** submenu. Enter the following parameters:

- **SMTP Server** and **SMTP Port**: Enter respectively the name and port of the server in charge of routing the emails issued by the receiver.
The SMTP server you need to use depends on the network the receiver is connected to. In most cases, it is the one of your Internet Service Provider.
“25” is the well known port number for communications using the SMTP protocol.
- **Username** and **Password**: Give identification information allowing you to send emails to the specified SMTP server.
- **Sender Email Address**: Email address of the CORS station from which emails will originate. It is a good idea to keep the default email address (no-reply@proflex800.com), as it suggests that no response should be sent back to this address.
- **Notification Email Address**: Recipient email address, typically the email address of the CORS station administrator or of any person in charge of monitoring and maintaining the station. There can only be one recipient.
- **Verbose Level**: This field is used to control which of the possible alarms or warnings are allowed to trigger notification emails.
“Full email notification” will let all the alarms and warnings trigger emails (no filtering).
“Standard email notification” will only let the warnings and highest-priority alarms trigger emails (selective filtering).
“No email notification” will prevent the receiver from issuing any emails, regardless of the nature of the possible alarms and warnings.
- Click on the **Configure** button to save all your settings. An email is then sent automatically to check that the email notification process is now working.

Activating the Embedded FTP Server & Creating New Users

- Click on **Advanced Setup** and then on the **Embedded FTP Server** submenu. Enter the following parameters:
 - Enable the **Activation** check box to activate the embedded FTP server.
 - **FTP Port**: Keep the default option (21) as it is the usual port number used for most FTP applications.

- In the **Memory Location** field, choose the memory the FTP server will give access to.
 - In the **FTP Path** field, specify the path to the subdirectory (in the selected memory) the FTP server will have access to (syntax: /subdirectory/.../subdirectory/). The first and last slashes are optional.
 - **Administrator Username** and **Password** fields: Username and password for the administrator of the embedded FTP server (default: “admin”, “changeme”). Not to be confused with the administrator of the ProFlex Web Server. It is your responsibility to define distinct or similar connection profiles for these two administrators.
- Click on the **Configure** button to save all your settings.
 - Click on **Back** to return to the Embedded FTP Server web page.
 - In the Users pane, enter as many user profiles for the Embedded FTP server as necessary.

For each user, enter a **Username** and a **Password**, then click on **Add/Modify**.

To modify the password of a user profile, click on the corresponding username in the table on the right. This updates the **Username** and **Password** fields with the current settings of this profile. Edit the password and click on **Add/Modify**.

To delete a user profile, click on the corresponding username in the table on the right and click on **Delete**.

Setting the External Sensors

Before starting, you should know which sensors are used, and which receiver ports they are connected to.

If port B or F is used, you should first go to **Connections - Serial Ports** and enable the **Power ON** box, followed by a click on the **Configure** button.

Setting a tiltmeter or a meteorological unit refers to the same procedure. For this reason, only the setting of a meteorological unit is described below.

- Click on **Connections** and then on **Meteorological Unit**.
- Identify the pane describing the serial port to which the sensor is connected (Serial Port A, Serial Port B or Serial Port F). Then set the parameters located inside this pane as follows:
 - Enable the **Process Meteorological Unit** option so that the receiver can start querying the sensor right after clicking on **Configure**.

- Set the port's **Baud Rate** and **RTS/CTS**
- Enter the **Initialization String** and **Trigger String**. These are parameters specific to the sensor used. They should normally be found in the manufacturer's documentation.
- Set the interval of time, in seconds, through which the receiver queries the meteorological unit (**Interval**).
- Set the **Legacy D-File Support** option as needed. Enabling this option means that the sensor data will not only be inserted into the collected G-file but also saved as a separate D-file. With this option cleared, no D-file will be created.
- Click on the **Configure** button to save all your settings.

Adding Delivery of Real-Time RTK Corrections

The ProFlex 800 CORS has the capability to deliver RTK corrections (differential messages) for real-time applications while being also busy collecting raw data files.

As an example, the instructions below allow you to configure the CORS station to perform Ethernet data streaming, delivering compact ATOM differential data on two IP ports (13, 15). In one case, the station will be a server, and in the other it will be the client of, for example, 10.20.2.71.

- Click on the **Configuration** tab and then on **Data Output - Differential Messages**
- Select “Compact (Static Base)” in the **RNX Scenario** field
- Keep the default settings for the refresh rates of the associated parameters.
- Click on the **Configure** button to save all your settings.
- Click on **Base Setup - Data Streaming on IP** and perform the following settings in the Ethernet Streaming pane:

Ethernet Streaming

Port #	Mode	Protocol	IP Address	IP Port	Message Type	
Port 11	<input type="checkbox"/> Server	TCP		1001	RTCM3.x	ⓘ
Port 12	<input type="checkbox"/> Server	TCP		1002	ATOM	ⓘ
Port 13	<input checked="" type="checkbox"/> Server	TCP		1003	CMR+	ⓘ
Port 14	<input type="checkbox"/> Server	TCP		1004	CMR	ⓘ
Port 15	<input checked="" type="checkbox"/> Client	TCP	10.20.2.71	1005	RTCM2.3	ⓘ
Port 16	<input type="checkbox"/> Server	TCP		1006	None	ⓘ
Port 17	<input type="checkbox"/> Server	TCP		1007	None	ⓘ
Port 18	<input type="checkbox"/> Server	TCP		1008	None	ⓘ
Port 19	<input type="checkbox"/> Server	TCP		1009	None	ⓘ

18(1.00s), 19(1.00s), 23(31.00s), 24(13.00s)

Configure

- Click on the **Configure** button to save all your settings.

For more information on the various possibilities of routing differential data to users, refer to the *ProFlex 800 Web Server Getting Started Guide* or the *ProFlex 800 Reference Manual*.

NTRIP Server Via Ethernet

- Click on **Base Setup > NTRIP Server**.
- Scroll down the page to display the “NTRIP Server 1” frame. In the **Connection** field, select “External NTRIP Caster via Ethernet”.
NOTE: If the Embedded NTRIP Caster firmware option is activated, a third option is available (“Embedded NTRIP Caster”) through which you can connect the NTRIP server directly to the embedded NTRIP caster (instead of connecting it to an external NTRIP caster).
- Enter the information (**Connect Now, Address, Port, Password, Mount Point**) allowing the base to connect to the NTRIP caster (the server) to which it is supposed to deliver its corrections.
NOTE: If you chose “Embedded NTRIP caster”, the **Address** field has been unconditionally set to “localhost”.
- Enable **Connect Now** to allow the receiver to establish the connection right after you have clicked on **Configure**.
- In the **Message** field, select the type of differential data the base will deliver (ATOM, RTCM, CMR or DBEN). Following your selection, you will see the detail of the selected data by placing the cursor over the “I” sign on the right of this field, as defined in **Data Output > Differential Messages**.
- If you need to define a second NTRIP server, scroll down to the “NTRIP Server 2” frame and resume the above steps.
- Click on the **Configure** button to let the Web Server load all your new parameters to the receiver.

Setting the Embedded NTRIP Caster

Remember the Embedded NTRIP Caster will be visible on the Status and Configuration tabs of the Web Server only after the NTRIP Caster firmware option ([C] option) has been activated in the receiver.

- Click on **Embedded NTRIP Caster > Settings**
- Enable the **Activation** button to start the embedded NTRIP caster (start-up will be effective after you have clicked on the **Configure** button).
- Enter the public IP address (or hostname) and IP port of the NTRIP caster:

By default the **Caster Hostname or IP Address** field shows the local IP address of the receiver (the one that can be read on the receiver display screen).

If the Ethernet port is set to work in DHCP and you have declared a hostname on the DynDNS site, then the field should be updated to hold that hostname.

If on the contrary, the public IP address to communicate with the receiver is a static address, then it should be known to the station administrator and entered in that field.

By default the **Caster Port Number** field reads “2101”. This value should not normally be changed.

- Define a password that NTRIP servers will have to provide for being authorized to connect to the NTRIP caster as correction data providers. Enter this password in the **Caster Password** field. The password can be displayed in plain by clicking on the **Show Characters** button.
- Use the **Maximum Simultaneous Connections per User** field to increase the number of connections a user can make at a time (default: 1). The upper limit is 100.
- Use the **Caster Information** area to enter informative data about the NTRIP caster. The whole set of information entered in this area will be made available to NTRIP caster users through the so-called NTRIP Source Table.
- Click on the **Configure** button to load all the NTRIP caster settings to the receiver.
- Click on **Embedded NTRIP Caster > Mount Points**. Use this tab to define all the mount points the NTRIP caster will have to manage. Behind each mount point is a base station installed at a given location and generating a given data format.

While most of the data presented to define a mount point are mostly informative (identifier, data format, approximate location of the base, country, fee indicator), the **Name** field on the contrary is the key parameter through which the NTRIP caster will organize the connections between NTRIP servers and NTRIP clients (users). So each mount point name should be chosen to depict as accurately as possible the source of corrections available through the mount point. Making all those names as short as possible is also recommended for the convenience of NTRIP clients.

For example, the mount point corresponding to a base station installed near the town of Balville and generating

ATOM differential data in compact format could be named: "Balv_ATO_Sc100".

- After all the fields on the tab have been defined for a mount point, click on the **Add/Modify** button to save this mount point (there is no **Configure** button on the Mount Points tab). Resume this operation until all the required mount points have been created.
- At this point, now that all the mount points have been defined, you should make sure all the NTRIP servers are properly configured to serve the embedded NTRIP caster, i.e. their IP connection settings should mention the IP address or hostname of the NTRIP caster, the corresponding mount point name and the caster password.

If you plan to use internal NTRIP servers (there may be two in the ProFlex 800 CORS, see *NTRIP Server Via Ethernet on page 51*), then for each of them, you will have to choose a mount point from the list of existing mount points. For both, the IP address of the caster will be forced to "localhost". Unlike external NTRIP servers, the caster password is not requested when configuring an internal NTRIP server.

- Click on **Embedded NTRIP Caster > Users**. Use this tab to create the list of authorized users. For each user, a username and password, as well as the authorized mount points, should be defined.

Remember that not assigning any user to a mount point results in making this mount point accessible not only to all declared users but also to anyone who can connect to the NTRIP caster.

- After all the fields on the tab have been defined for a user, click on the **Add/Modify** button to save this user (there is no **Configure** button on the Users tab). Resume this operation until all the users have been created.
- At this point, now that all the users have been defined, you should provide all these users with the following information so they can connect successfully to the NTRIP caster:
 - Caster IP address or hostname
 - IP port
 - Username and password
 - List of authorized mount points.

Monitoring ProFlex 800 CORS

Reading the Status pages of the ProFlex Web Server is a nice way of monitoring ProFlex 800 CORS through an IP connection. Opening the web pages requires that you log in either as the administrator or as a simple user.

This section gives a quick overview of the monitoring function. For a detailed description of all the status pages, refer to *the ProFlex 800 Reference Manual*. For a detailed description of the Status Bar, you can also refer to *Status Bar and Units Used on page 37*.

After configuring ProFlex 800 CORS, you can cast an eye at the Status bar to check that (from left to right):

- The receiver mode is “Base”
- There is enough free memory
- The Sessions status is as expected (Off, On or Recording)
- The computed latitude longitude and ellipsoidal height are close enough to the entered reference position (to within a few meters)
- The values of HDOP and VDOP are low enough (less than 3)
- There is a sufficient number of received satellites (used/tracked)
- No alarm has been triggered.

You can also go to the **Status** tab and click on **Receiver Status & Settings**. The resulting web page will give an overview of the station operation.

A click on **Satellites** will tell you more about the satellites received for each GNSS used.

A click on **System** will list the current status of the different hardware components of the receiver.

A click on **Connections** and then on each of its submenus will list status information for the different communication components or external devices used.

A click on **Data Output** will list the currently programmed data outputs.

A click on **Alarms** will list the alarms that have been triggered so far.

A click on **Version** will give identification information about the various hardware components used in the receiver.

Symbols

\$PASH commands 36

Numerics

702450 (cable) 35

A

AC/DC power supply kit 4

Address box 36

Administrator profile 37

ADVNULLANTENNA 42

Age of corrections 38

Alarm status 14

Alarms 7

Angle units 39

Antenna (GNSS) 4

Antenna Height 41

Antenna Radius 42

ARP 41

ATL 14

ATOM 2, 20

Auto Set 44

Automatic Transfer 25

Automatic transfer (to FTP) 47

B

Backlight 7

Backup battery 10

Backup FTP server 1, 20, 26, 47

Base Setup 41

Battery 38

Battery (insert) 12

Battery (remove) 11

Battery charger 4

Battery icon 14

Battery model 9

Bluetooth antenna 3, 5

Bluetooth identifier 16

Bluetooth status 15

Buzzer 9

C

Cable pinout (external sensors) 35

CAN bus 9

Caster hostname 52

Cellular antenna 3, 5

Charging battery 11

Clear All button 43

Company name 37

Configuration tab 37

Connect Now 51

Conversion (to RINEX) 46

Convert G-files 24

D

Data output, CORS 43

Data recording (out of sessions) 27

Data Streaming on IP 50

Data transfer screen 18

Date 39

DC power input 7

Delete Files After Transfer 26, 47

DHCP 52

Direct IP 2

Display screen 6

Distance units 39

Dynamic 41

E

Earth terminal 9

Electric isolation (optical) 9

Email (owner email) 37

Email alerts 32

Email notifications 47

Embedded FTP server 2, 33, 48

Embedded NTRIP caster 1, 20, 28, 51

Embedded NTRIP caster (current) 31

Embedded NTRIP caster (emulating Direct IP mode + protection) 29

Embedded NTRIP caster (history) 31

Embedded NTRIP caster (log) 31

Embedded NTRIP caster (settings) 30

Ethernet adaptor cable 3

Ethernet data streaming 2

Ethernet port 8

External sensors 34, 49

F

Factory settings 10

Firmware update 10

Firmware version 16

FTP server (external) 25

Full Notification 33

G

General Status screen 13

Get Current Position 41

G-files 23, 24, 25, 34, 43

GLONASS 42

GNSS input #1 7

GNSS input #2 8

Ground Mark 41

GSM 2

GSM antenna 3, 5

GSM status 14

H

Hatanaka 24

HDOP 38

Height 38
Home tab 36
Host cable (USB) 3
HRMS 38

I

Initialization String 50

K

Key combinations 10

L

L1 phase center 41
Latitude 38
Latitude (entering a latitude, possible formats) 39
LED status (battery charger) 12
Legacy D-File Support 50
Li-ion battery 3
Log button 7
Longitude 38
Longitude (entering a longitude, possible formats) 39

M

Manual Set 45
Maximum Simultaneous Connections per User 52
Measurement Type (antenna) 41
Memory 38
Memory screens 15
Meteorological unit 34, 49
Modem power status 38
Monitoring 54
Mount point 51
Mount points 1, 28, 52
Mount points (protection) 32
Move files 24
Moving Position 41

N

Navigation data 24
NMEA2000 9
No Notification 33
Notification Email Address 48
NTRIP server 2, 51
NTRIP Server via Ethernet 51
NTRIP servers (internal) 28
Number of received vs. used satellites 38

O

Offset Per Day 23, 45
OLED 6
Owner name 37

P

Pages (of information) 7

Path 26, 47
Phone (owner phone) 37
Port P 28
Port Q 28
Position computation screen 16
Power button 6
Power LED 6
Power status 14
Power-on screen 13
Primary FTP server 25

R

R port 23
Radio 2
Raw data 7
Raw data icon 14
Raw data type 23
Receiver Antenna 41
Receiver identification screen 16
Receiver serial number 16, 37
Recording Elevation Mask 42, 45
Recording elevation mask 23
Recording menu 27
Recording status 38
Reference clock 8
Reference Day 22, 45
Reference position 41
Reference Position (antenna) 41
Re-start (automatic or manual) 10
RINEX 2, 24, 43
Ring File memory 1, 23, 46
RNX scenario 50

S

Satellites in use 13
SBAS 42
Scheduling (sessions) 44
Screen backlight 18
Scroll button 6, 7, 12
Sender Email Address 48
Serial data cable 3
Serial ports 8
Sessions 14, 21, 23, 24, 25
Sessions (programming) 44
Sessions (settings) 45
SHMP Offset 42
Signal strength (modem) 38
Site Name 38
Site name 23
Slant height 41
Sleep mode 21
Slide switch (for re-start setting) 10
SMA 5

SMTP server *48*
Standard Notification *33*
Station ID *38*
Status (position) *13*
Status bar *37*
Status tab *37*
Storage medium *24*
Sub-directory Name Format *25, 26, 46, 47*

T

TarZ *24*
Tiltmeter *34, 49*
Time *39*
TNC/TNC coaxial cable *4*
Trigger String *50*

U

UHF input *8*
Units used *39*
USB device *23*
USB port *6*
USB status *15*
Use box *45*
User profile *37*
Users (NTRIP caster) *28, 53*

V

VDOP *38*
Verbose Level *48*
Vertical height *41*
Virtual Antenna *42*
VRMS *38*

W

Web browser *20*
Web Server *1, 20*

X

XDR messages *34*

Getting Started Guide

Contact Information:

Spectra Precision Division
10355 Westmoor Drive,
Suite #100
Westminster, CO 80021, USA
www.spectraprecision.com

Ashtech S.A.S.
Rue Thomas Edison
ZAC de la Fleuriaye, BP 60433
44474 Carquefou Cedex, FRANCE
www.ashtech.com

